

Tandberg Series 3000 Separates

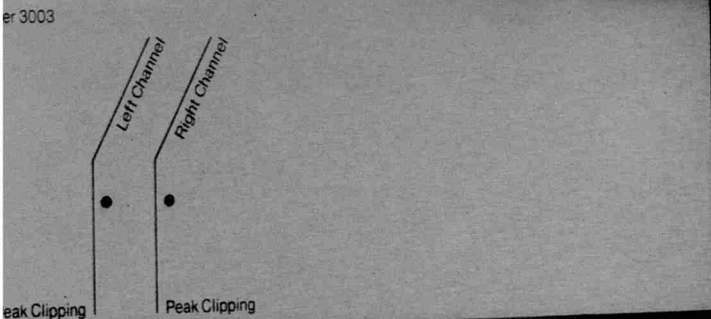
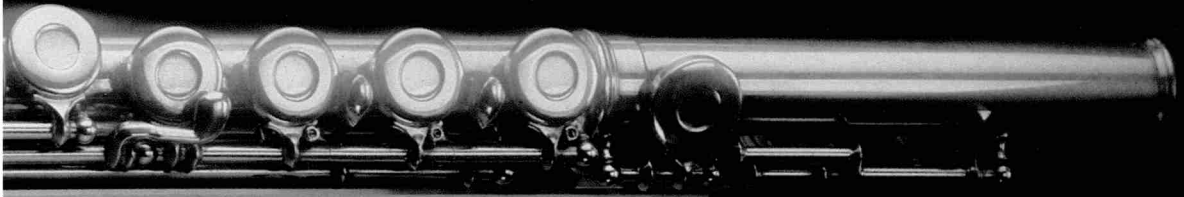

**Tandberg TPT 3001.
Programmable Tuner.**

The TPT 3001 is the sensitive ear of the Series 3000. The design aim was to create a tuner with no compromise – the world's finest FM tuner. The result is a signal to noise ratio previously unheard of in an FM tuner. Noise levels of better than 90 dB below the signal level in stereo.

Long term development in the Tandberg laboratories has produced a host of advanced features – including a remarkable stereo decoder that takes full advantage of the excellent front end signal to noise ratio.

Ultimate Signal to Noise Ratio.

Like the sensitivity, the ultimate signal to noise ratio is determined by the component quality and the applied level of technology in the unit's circuitry. In the TPT 3001, the extraordinary ultimate signal to noise ratio is achieved by the unparalleled overall engineering and design. In fact, the ultimate signal to noise ratio is limited only by the laws of physics: that is by the thermal resistance of the load impedance of the detector itself. (Fig. 1)

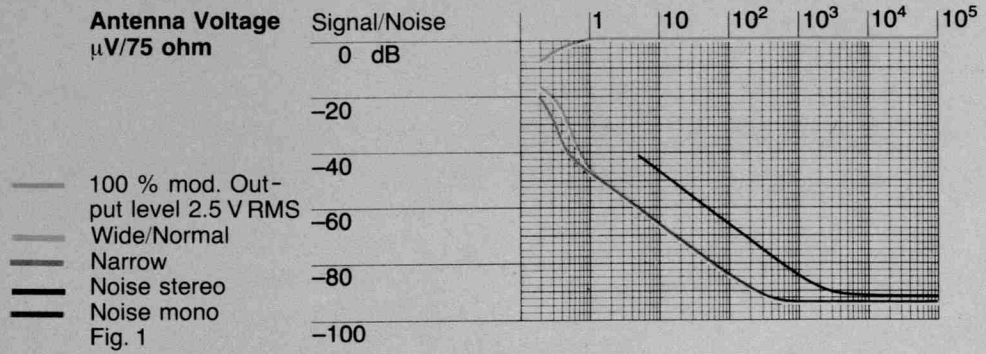

Sensitivity

The sensitivity of a tuner is determined by the component quality, the applied level of technology and the physical layout of the electronic circuitry. The highest design skills have gone into the electronic layout of the TPT 3001, which utilizes metal film resistors and specially selected transistors and capacitors.

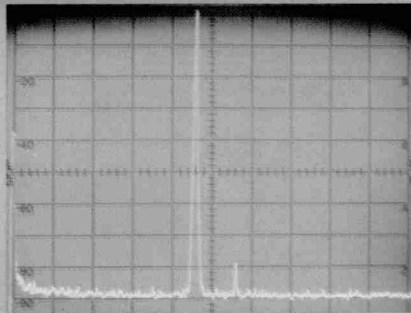

Fig. 2 TPT 3001

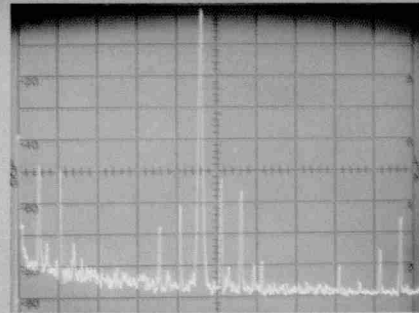

Fig. 2 Other high quality tuner

Stereo Decoder.

Even if a tuner is excellent for monophonic reception, the distortion in stereo introduced by the stereo decoder is often considerably higher than expected, even if the harmonic distortion is very low. This is caused by the intermodulation between the pilot tone, the subcarrier and the programme, creating beat notes at certain frequencies non harmonic to the programme. In fact, reducing the inter-

modulation and the beat notes of the decoder is much more important than reducing the harmonic distortion, because the ear is much more sensitive to non harmonic distortion than it is to harmonics. The TPT 3001 overcomes this problem and avoids beat note generation by using discrete components of the highest quality in the signal handling stages. The result is clearly shown by comparison in Fig. 2.

**Tandberg TCA 3002
Control Amplifier.**

The TCA 3002 is the command module of the Series 3000. Computer-aided design technique and the incorporation of the latest semi conductor technology maximise sensitivity and reduce hum and noise to a bare minimum.

The clean, stylish appearance of the TCA 3002 is matched by an internal layout unique in it's uncluttered precision. Technical sophistication is allied to a spread of functions and controls that will accommodate all load conditions.

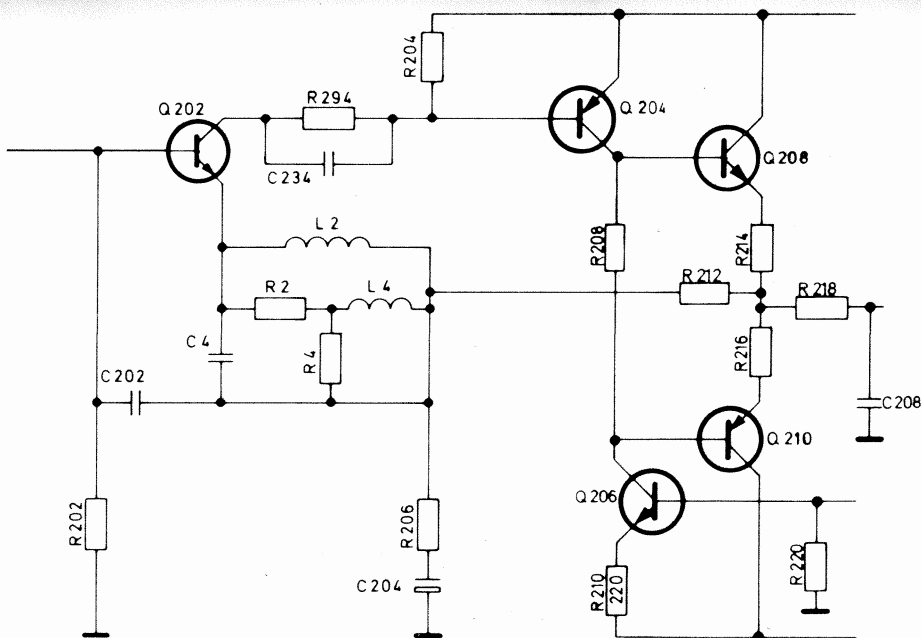
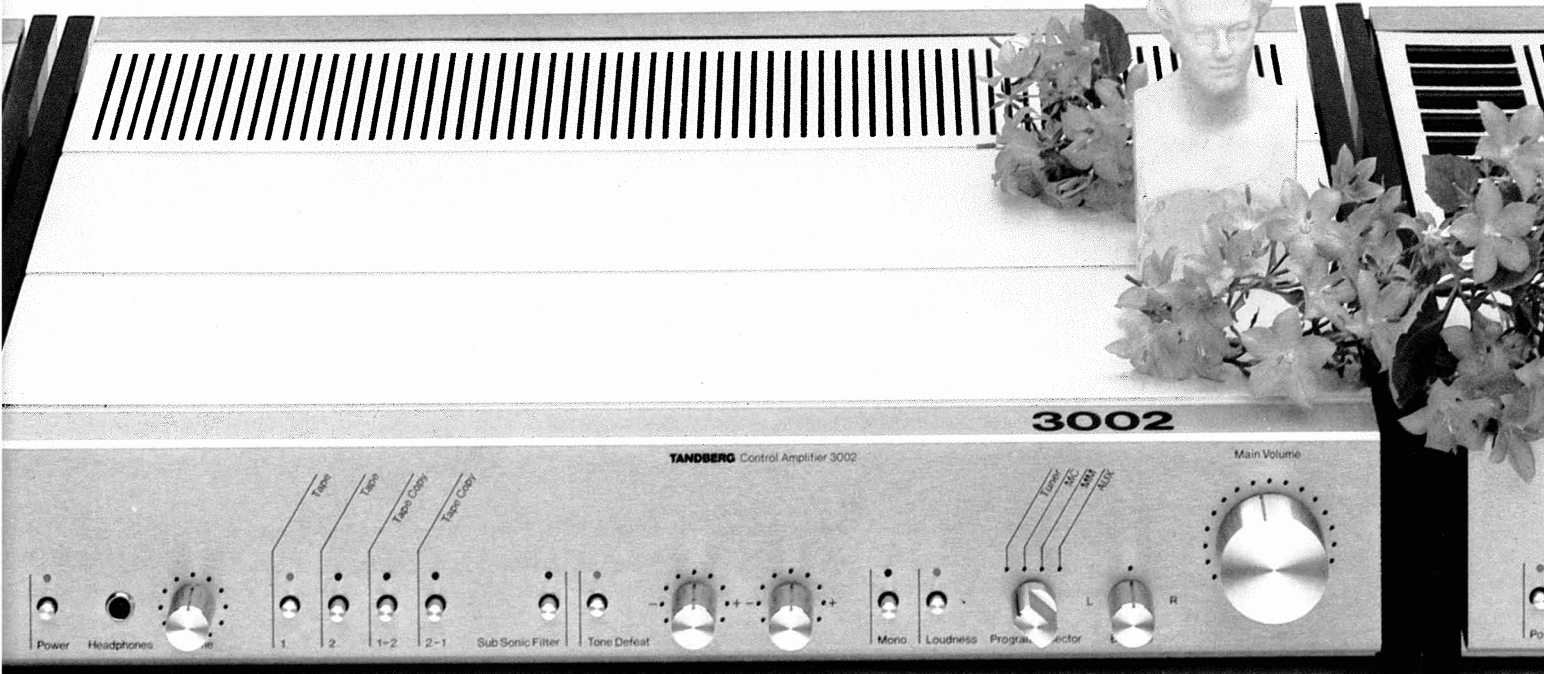

Fig. 3

Amplifier Quality.

Combining high sensitivity, high signal to noise ratios and high overload margins in a pre-amplifier is always difficult because these demands are contradictory. Yet it is vital to achieve this aim and, at the same time, to minimize distortion and increase amplification speed.

The TCA 3002 solves these problems by incorporating two separate RIAA amplifiers, one for moving coil and one for moving magnet pickups. Both have linear input stages with an open loop compensation of 9 dB/oct., instead of 6 dB/oct., giving the best combination of speed and stability.

To make this possible, Tandberg developed a special input circuitry (Fig. 3) which gives a transient intermodulation so low that it cannot be measured, even with the finest instrument, and a slew rate higher than 300 V/μs.

**Tandberg TPA 3003
Power Amplifier.**

The TPA 3003 is the powerful heart of the Series 3000. Compact and elegantly styled the TPA 3003 offers the discerning listener clean power and utter reliability. Built to deliver a potent 150 watts per channel into 8 ohm, it reduces distortion to less than 0.01 %.

The very latest advances in amplifier technology are incorporated into the TPA 3003 to produce sound quality of an uncanny clarity and detail, and under a wide range of operating conditions.

Stability.

As in the TCA 3002, speed and distortion are controlled by a 9 dB/oct. compensation circuitry giving optimum stability not only in a resistive load, but also in a reactive loudspeaker impedance. The DC stability is very high (see Fig. 4) due to the circuit design, the large toroidal transformer, the 25 A rectifier and the large filter capacitors 2 X 15000 μ F.

Safety of Operation.

The TPA 3003 has five different protection circuits and a highly efficient cooling system that gives rapid air circulation to the transistors. The temperature is kept at a safe level under all operating conditions.

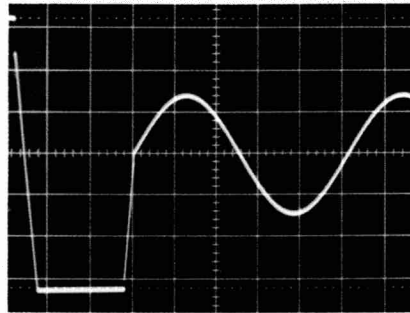

Fig. 4



**Tandberg Series 3000
The Separates of The 80's.**

Together with the TCD 3004 professional cassette recorder and the TML 3005 monitor loudspeakers, the TPT 3001, TCA 3002, TPA 3003 form the ideal Hi Fi system, a system that approaches sound perfection.

Accessories.

The units can be free standing, or mounted in a standard professional 19

inch rack. Side walls and mounting brackets with handles can be supplied as accessories.

Tandberg is registered trademark for Tandberg A/S.

World Headquarters:
Tandberg A/S,
Post Office Box 53,
N-2007 Kjeller, Norway.



Tandberg – The European Alternative

A new standard in sound reproduction.

The Tandberg Series 3000 is quite simply a new standard in sound reproduction. A totally integrated system of audio separates that scales new peaks in performance, reliability and elegance.

Tandberg set out to create the ultimate system. A system against which others would be measured. A system with no compromise.

The result is a masterpiece of European technology. Components which, separately, define the state of the art in their field and which, together,